

Largo & Allegro

Air Compressors

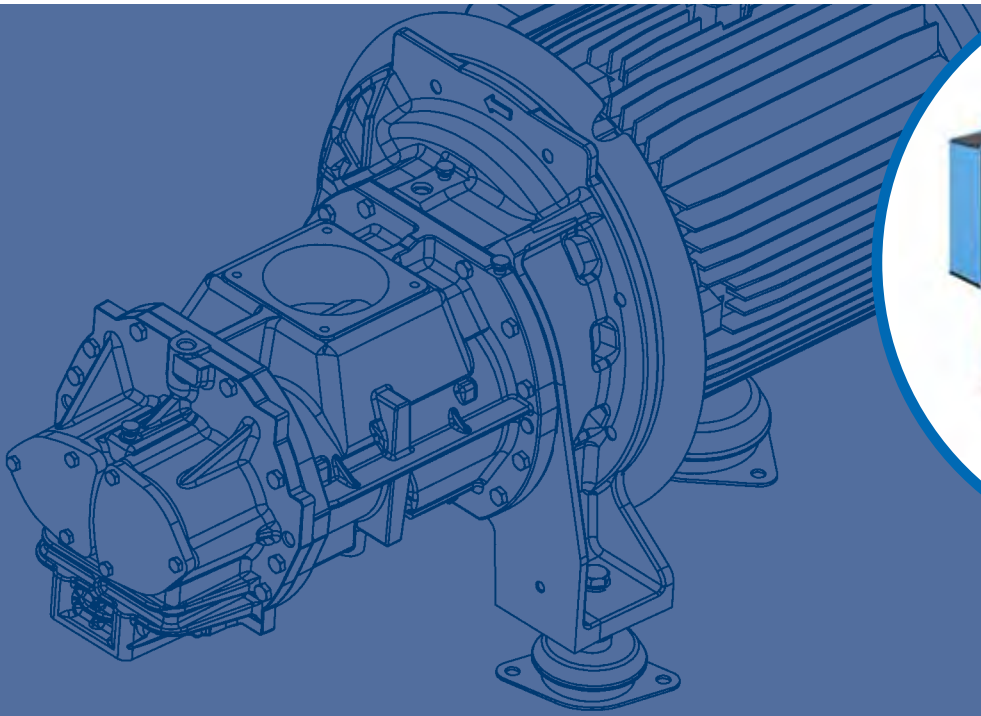

LARGO & ALLEGRO 31-90

ALUP
Kompressoren



ALUP

Driven by technology. Designed by experience.

ALUP Kompressoren has over 85 years of industrial experience. It is our ambition to offer compressed air solutions that ensure we are first in choice for our customers. To reach this goal we need continuous investment in our product development to make sure that we are always able to offer:

- High performance and excellent quality
- Integrated engineered solutions
- Full energy efficiency
- Total cost of ownership
- Environmental care

www.alup.com



The power of the Largo & Allegro range

Largo & Allegro 31-90 screw compressors provide high-quality compressed air for a range of industrial applications. The result of continuous investment in product development, Largo & Allegro 31-90 compressors are built around three innovative features which make them stand out.

Gearbox driven units

- Highly energy-efficient, with no long-term loss.
- Energy consumption reduced by up to 3% compared to belt driven technology.

State-of-the-art controllers

- Full-colour graphic screen for Air Control 5.1 (on IVR machines).
- Intelligent unload cycle control.
- Wide range of timers to efficiently adapt to your needs 24/7.
- Outstanding communication possibilities.
- Fully compatible with Air Control family.

Modular design

- Ensuring ease of maintenance.



The range that meets all your requirements

In the Largo & Allegro 31-90 range you can find the right compressor model to match your precise requirements.

The output you require

- Models available from 40 to 125 hp.
- 4 pressure variants per compressor.
- 2 Allegro variants with different pressure ranges.

The performance you are looking for

- Designed for harsh conditions and ambient temperatures up to 46°C.
- Water-cooled variant offers even greater performance and lower noise levels.

The energy efficiency you need

- Largo is the load/unload variant used for a base load where you need continuous maximum air output.
- Allegro is the frequency-driven variant used for variations of output where it absorbs fluctuations with optimized energy consumption.

The options you need

- Integrated dryer for all models up to Largo 75.
- Integrated water separator for optimum air quality.
- Integrated central controller to ensure better communication between the different compressors in the room and increase efficiency.



Energy audit

To optimize your energy efficiency, you need to select the right compressor. Contact your local ALUP representative and we will perform a simulation based on your parameters to help you get the perfect compressed air solution.

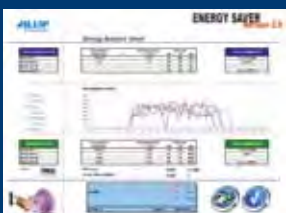

One package – multiple benefits

Check out these innovative features of the Largo & Allegro 31-90 range and see how they provide you with high efficiency, ease of maintenance, low noise levels and outstanding cooling.

Improved efficiency

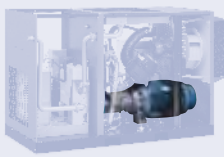

High quality drive train (direct driven transmission)

- Gearbox technology for outstanding energy efficiency and reliability.
- No long-term loss thanks to the combination of screw and gearbox technology.
- All units incorporate adapted gear sets for optimal efficiency.
- Innovative gearbox for a small footprint.



Same motor manufacturer for all models

- Standard, efficient IE2 motor.
- Optional IE3 motor for enhanced compressor efficiency.
- One brand for all drive train motors eases maintenance.

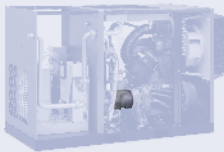

In-house designed elements

- High performance (energy/Free Air Delivery).



Air Control 5.1

- Standard on IVR machines, available as option for fixed speed machines.
- Intelligent unload cycles.
- Multiple clock settings for multiple pressure bands adapted to the air consumption.
- Fully compatible with Air Control family.
- Full-colour easy-to-use screen & extended communication possibilities.



Lower noise level

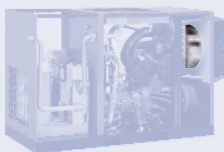

Radial fan

- Low power consumption & reduced noise levels.
- High-efficiency cooling flow.
- Long lifetime of oil, components and compressor.

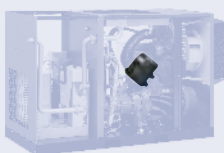

Standard enclosed intake filter

- Low noise thanks to design and position of filter.
- Air intake in cold part of the compressor for improved FAD.
- High filtration quality.

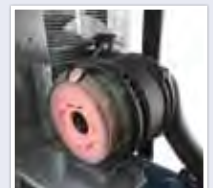



Ease of maintenance



Solid inlet baffle

- Small installation footprint: the unit can be placed against a wall.
- Fitted with insulation foam to reduce noise.
- Optimized air flow for improved cooling.
- Protection against touching the fan.

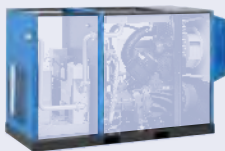

Innovative canopy

- Servicing doors mounted with removable hinges, robust door locks.
- Soundproof insulation material on all canopy parts.
- Small footprint.
- Protection bolts for trouble-free transportation (with a pallet and forklift).

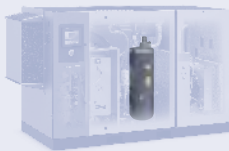

Inhouse designed oil separator vessel

- Integrated minimum pressure valve (MPV) eliminates risk of leakage.
- Long lifetime thanks to cast iron parts.
- Designed for optimal oil separation.



Separate inverter cubicle

- Easy access for maintenance and cleaning.
- Optimal cooling of inverter guarantees long lifetime of components.



Better cooling

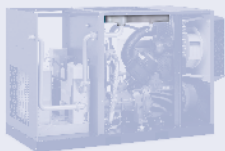

Separate oversized coolers

- Separate oil and air cooler for high-quality cooling and long lifetime of the coolers.
- Gliding rails for easy and safe removal.
- Easy access for cleaning.

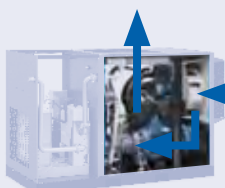

Improved motor cooling

- Separate cooling flow.
- Suitable for harsh conditions and temperatures up to 46°C.

ENERGY EFFICIENCY PACK

Optimize your energy efficiency

Energy costs represent about 70% of the total operating cost of your compressor over a 5 year period. That's why reducing the operating cost of a compressed air solution is a major focus. The Allegro variable frequency drive compressor can cut the energy bill of your compressor by up to 30%.

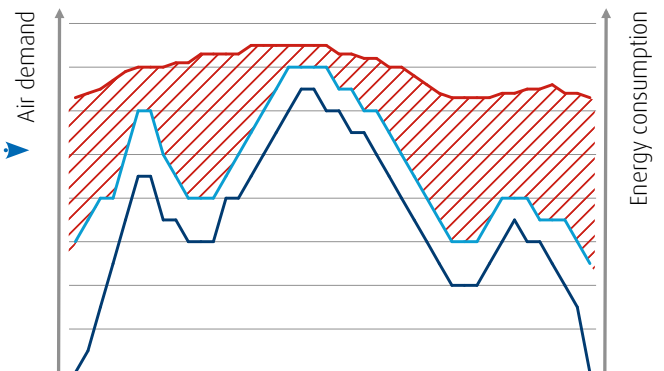
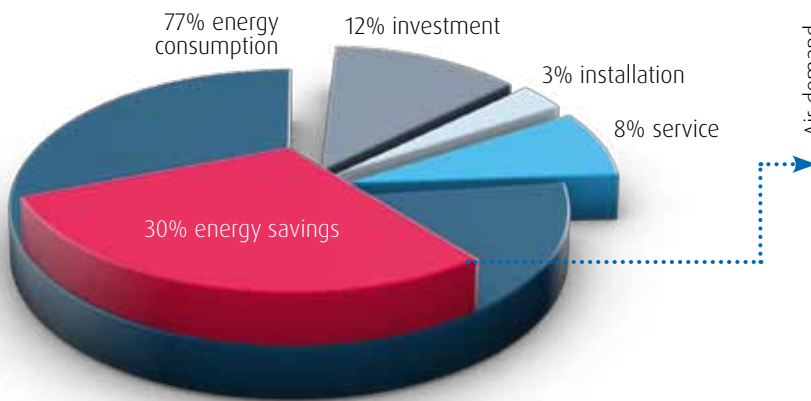

— Air demand
— Variable frequency driven costs
— Load unload costs
▨ Savings

The Allegro reduces energy consumption in the following ways:

- The variable frequency drive compressor (inverter technology) guarantees a fixed set pressure operation and matches air supply with air demand.
- No unload cycles above 20% load.
- No peak current due to soft start.



Allegro: Built for superior efficiency

Standard units are engineered so that multiple features which reduce the energy consumption of the package can easily be integrated. One of these is the variable frequency drive device:

- **High efficiency motors** – Standard IE2 motor; optional IE3 motor.
- **Direct drive transmission** – The most energy efficient mode of transmission, reducing energy consumption by 2-3%.
- **Cooling turbine** – While maintaining a high cooling efficiency, radial turbine energy consumption achieves superior cooling.
- **Air Control management** – Designed with a special energy-saving algorithm. A more advanced Air Control Graphic variant is used to provide more data inputs and improve system management.

Allegro: Standard industrial technology

The use of standard industrial devices increases package reliability (inverter technology):

- **Frequency-driven device** – The Allegro frequency converter is a reference in the industry and is used in multiple applications where a frequency-driven process is a must.
- **Dust protection** – All electronic devices are integrated in protected housing to avoid external dust contamination and maintain efficient cooling flow in the converter.
- **Standard EMC certification.**

Electronic Air Control 5.1 Controller

The Air Control 5.1 Controller allows you to operate the compressor in an easy and organized way:

- Stop/start timers do not rely on the operator's action to save energy, but program the Air Control 5.1 Controller to operate as your factory operates.
- Dual pressure band time scheduling for operation with different pressure bands, leading to energy savings.
- Automatic restart after a power cut with sequence restart avoids simultaneous starts in the compressor network, extending reliability.
- Off-load cycle delay postponement.
- Service indicator and fault management provide comprehensive messages to ease service diagnostics.
- Air Control Graphic provides additional functionalities:
 - o User-friendly screens, data logging and storage on a memory card.
 - o Connectivity to ensure efficient pressure regulation when combining a variable speed and fixed speed compressor. Air Control Graphic functions as a master control to all other fixed speed Largo compressors in the room, harmonising their operations.



Controller



Menu screen



Data logging screen

Improve your energy recovery

When air is compressed, heat is formed. The excess heat can be captured with an energy recovery option and channelled to other applications allowing you to save energy and cut costs.

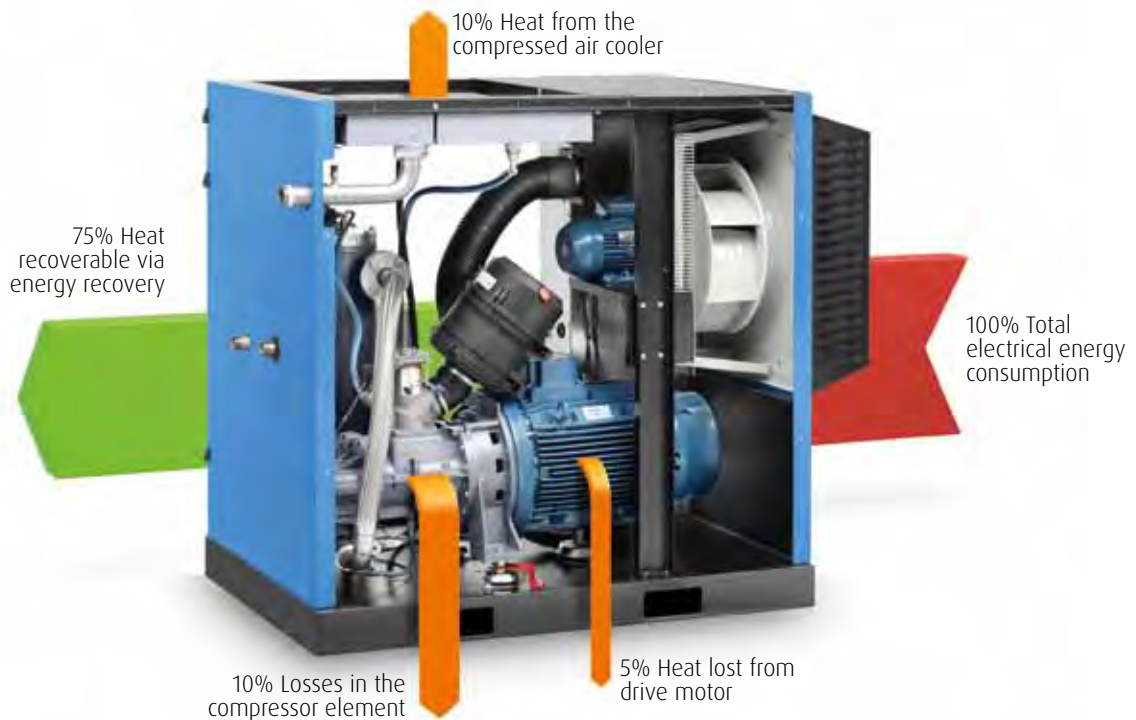

Water cooling recovery

In the case of water-cooled or air-cooled compressors, the oil circuit is pre-cooled with an oil/water heat exchanger. Water then becomes the fluid transport media to recover the oil temperature. The hot water resulting from this process can be used to heat radiators or water boilers, pre-heat supply water or hot tap water, and other industrial applications.

The energy recovery option integrates a heat exchanger on the oil circuit, which heats up the continuously pressurized water flow. The system is regulated automatically, and in case of limited water cooling capacity, the standard cooling system of the compressor will operate and backup the energy recovery device.

The energy recovery option is a simple mechanical system that requires no maintenance or electricity consumption, but offers you significant reductions in your energy costs.



AIR QUALITY PACK

Enhance your air quality

Atmospheric air entering the compressor contains humidity and dust. A refrigeration dryer with the appropriate filtration removes this contamination and water after the compression process. The dryer protects the air network against corrosion, preserves the final product quality and reduces maintenance and operating costs.

Largo & Allegro compressors are available with an integrated dryer option, which offers significant advantages compared to a stand-alone dryer:

- **Capture air humidity right at production** – The air is dried downstream from the air after-cooler, leaving no room for compressed air to condense and stagnate in the air network.
- **Reduced footprint and compact installation** – An integrated dryer is about three times more compact and allows the unit to be installed close to point of use.
- **Intelligent dryer control** – The dryer is connected and controlled by the Air Control 5.1 Controller for improved regulation.
- **Continuous operation** – The operation of the dryer has no impact on air delivery.
- **Designed to run at maximum operating conditions** – Compared to a stand-alone dryer, the drying capacity of an integrated dryer is increased to maintain its performance under maximum operating conditions of the compressor, i.e. 46°C.
- **Single service visit** – An integrated air dryer improves service operations, extending the lifetime of your equipment.
- **No installation cost.**



Perfect integration

Our integrated dryer module is designed and assembled in-house with top quality components, in line with our highest engineering and quality standards. In addition, we provide comprehensive service support to ensure the optimal lifetime of your integrated dryer.

Options to optimize your operations



A wide range of options enables you to get the most out of your Largo & Allegro 31-90 compressor.

- **Internal water separator** reduces up to 90% of the condensate in the compressed air.
- **Automatic drain** ensures no air loss during condensate removal (only in combination with internal water separator). Can be used with various types of oil: 4000 h, 8000 h and food grade oil.
- **High-efficiency air intake pre-filtration panel** avoids dust entering the compression element, protecting internal components and extending compressor lifetime.
- **Optimal energy recovery pack** recovers a lot of the energy used to activate the compressor as heat, which can be used to heat up water for showers, boilers etc.
- **IE3 motor** increases compressor efficiency, resulting in lower energy consumption and cost savings.
- **Wrong rotation direction control** protects the compressor from possible damage when the power supplied by the energy provider is unreliable.
- **Water shut-off valve outside the canopy** for water-cooled machines.
- **Main power switch**, in addition to the standard emergency stop button.
- **Remote monitoring** for additional convenience.
- **Wooden box** for overseas transport.
- **Tropical thermostatic valve** for use in humid and hot conditions.
- **ES 4/6i** integrated multiple compressor control for 4/6 compressors.

For further information on how our options can optimize your operations, please contact your local representative.

Technical specifications

Fixed Speed

Model	Max. working pressure	Reference working pressure	Free Air Delivery @ reference conditions *			Motor Power		Noise Level **	Cooling air Volume	Weight		Compressed Air output diameter
	bar	bar	m³/h	l/s	cfm	kW	hp	dB(A)	m³/h	std (kg)	T (kg)	"
LARGO 31	7.5	7	336	93	198	30	40	66	5400	790	975	1 1/2
	8.5	8	316	88	186	30	40	66	5400			
	10	9.5	284	79	167	30	40	65	5400			
	13	12.5	236	66	139	30	40	65	5400			
LARGO 37	7.5	7	414	115	244	37	50	67	5760	870	1055	1 1/2
	8.5	8	398	111	234	37	50	67	5760			
	10	9.5	357	99	211	37	50	66	5760			
	13	12.5	286	79	168	37	50	66	5760			
LARGO 45	7.5	7	485	135	285	45	60	68	7200	875	1060	1 1/2
	8.5	8	472	131	278	45	60	68	7200			
	10	9.5	432	120	254	45	60	67	7200			
	13	12.5	369	102	217	45	60	67	7200			
LARGO 55	7.5	7	595	165	350	55	75	70	9000	1130	1403	2"
	8.5	8	558	155	329	55	75	70	9000			
	10	9.5	519	144	306	55	75	69	9000			
	13	12.5	447	124	263	55	75	69	9000			
LARGO 75	7.5	7	774	215	456	75	100	71	12600	1317	1590	2"
	8.5	8	738	205	434	75	100	71	12600			
	10	9.5	663	184	390	75	100	70	12600			
	13	12.5	582	162	343	75	100	70	12600			
LARGO 76	7.5	7	882	245	519	75	100	69	12600	1570	NA	2"
	8.5	8	834	232	491	75	100	69	12600			
	10	9.5	742	206	437	75	100	68	12600			
	13	12.5	629	175	370	75	100	68	12600			
LARGO 90	7.5	7	973	270	573	90	125	70	14760	1600	NA	2"
	8.5	8	964	268	568	90	125	70	14760			
	10	9.5	880	244	518	90	125	69	14760			
	13	12.5	721	200	425	90	125	69	14760			

Inverter driven

Model	Working Pressure bar	Min. Free Air Delivery (7 bar) *	Max. Free Air Delivery															Motor Power		Noise Level **	Cooling air Volume	Weight		Compressed Air output diameter			
			7	7	7	7	7	7	9.5	9.5	9.5	10	10	10	12.5	12.5	12.5	13	13	13	kW	hp	dB(A)	m³/h	V	VT	"
			m³/h	l/s	cfm	m³/h	l/s	cfm	m³/h	l/s	cfm	m³/h	l/s	cfm	m³/h	l/s	cfm	m³/h	l/s	cfm					kg	kg	
ALLEGRO 31	4-10	101	28	59	336	93	198	289	80	170	281	78	165	n.a.	n.a.	n.a.	n.a.	n.a.	n.a.	30	40	67	5400	840	1025	1 1/2	
	4-13	87	24	51	291	81	171	289	80	170	289	80	170	236	66	139	229	64	135	30	40	66	5400				
ALLEGRO 37	4-10	124	35	73	414	115	244	357	99	211	347	96	204	n.a.	n.a.	n.a.	n.a.	n.a.	n.a.	37	50	68	5760	920	1105	1 1/2	
	4-13	107	30	63	360	100	212	357	99	211	357	99	210	286	79	168	277	77	163	37	50	67	5760				
ALLEGRO 45	4-10	145	40	86	485	135	285	419	117	247	407	113	240	n.a.	n.a.	n.a.	n.a.	n.a.	n.a.	45	60	69	7200	925	1110	1 1/2	
	4-13	126	35	74	422	117	248	419	117	247	419	116	246	369	102	217	358	99	211	45	60	68	7200				
ALLEGRO 55	4-10	179	50	105	595	165	350	519	144	306	504	140	297	n.a.	n.a.	n.a.	n.a.	n.a.	n.a.	55	75	71	9000	1200	1473	2"	
	4-13	156	43	92	523	145	308	519	144	306	518	144	305	447	124	263	434	120	255	55	75	70	9000				
ALLEGRO 75	4-10	232	65	137	774	215	456	663	184	390	643	179	379	n.a.	n.a.	n.a.	n.a.	n.a.	n.a.	75	100	71	12600	1387	1660	2"	
	4-13	199	55	117	667	185	393	663	184	390	661	184	390	582	162	343	565	157	333	75	100	70	12600				
ALLEGRO 76	4-10	265	74	156	882	245	519	737	205	434	715	199	421	n.a.	n.a.	n.a.	n.a.	n.a.	n.a.	75	100	70	12600	1640	NA	2"	
	4-13	221	61	130	741	206	437	737	205	434	735	204	433	629	175	370	610	169	359	75	100	69	12600				
ALLEGRO 90	4-10	292	81	172	973	270	573	846	235	498	821	228	483	n.a.	n.a.	n.a.	n.a.	n.a.	n.a.	90	125	71	14760	1670	NA	2"	
	4-13	254	71	150	851	237	501	846	235	498	845	235	497	721	200	425	700	194	412	90	125	70	14760				

* Unit performance measured according to ISO 1217, Annex C, latest edition

** Noise level measured according to ISO 2151 with optional baffle

All technical data for Aircooled machines without integrated dryer. For technical data of Watercooled machines or machines with integrated dryer, please contact your local salesforce

Dimensions

Fixed Speed

Model	Length std mm	Length T mm	Width mm	Height mm
LARGO 31				
LARGO 37	1684	2071	1060	1630
LARGO 45				
LARGO 55	1924	2510	1060	1630
LARGO 75				
LARGO 76	2124	NA	1060	1630
LARGO 90				

Inverter driven

Model	Length V mm	Length VT mm	Width mm	Height mm
ALLEGRO 31				
ALLEGRO 37	1684	2071	1060	1630
ALLEGRO 45				
ALLEGRO 55	1924	2510	1060	1630
ALLEGRO 75				
ALLEGRO 76	2124	NA	1060	1630
ALLEGRO 90				





DRIVEN BY TECHNOLOGY DESIGNED BY EXPERIENCE



**CONTACT YOUR LOCAL
ALUP
REPRESENTATIVE**

Your authorized distributor

6999640300

www.alup.com