

Practic - HLE

Piston Compressors

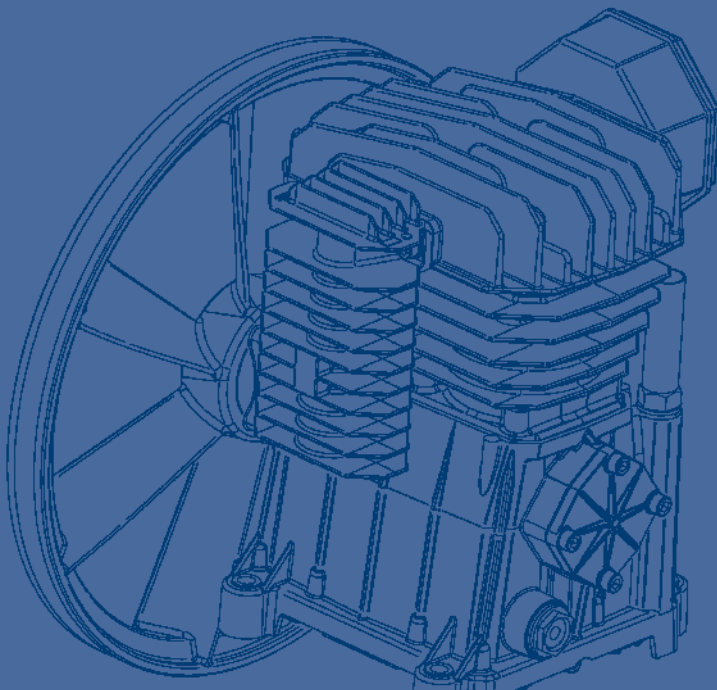

2 TO 10 HP - 6 TO 500 LITRES

ALUP
Kompressoren



ALUP

Driven by technology. Designed by experience.

ALUP Kompressoren has over 90 years of industrial experience. It is our ambition to offer compressed air solutions that ensure we are first in choice for our customers. To reach this goal we need continuous investment in our product development to make sure that we are always able to offer:

- High performance and excellent quality
- Integrated engineered solutions
- Full energy efficiency
- Total cost of ownership
- Environmental care

www.alup.com

The power of our piston range

Complete & comprehensive portfolio from 2-10 HP for DIY to industrial users

	PRACTIC HLE RANGE	HLE RANGE	HLE-S
Direct driven (2-3 HP)			
Belt driven single stage (2-3 HP)			
Belt driven two stage (4-10 HP)			

Simple installation

- Models available for occasional, intermittent or frequent use
- Prewired and different vessel sizes
- Quick fit connector



Solid quality

- Slow running pump design
- Robust belt guard design

Efficiency

- Low power single phase motor – direct drive
- Slow running pump design for less wear and noise – belt drive
- Low & easy maintenance with original parts



Air quality (HLE-S)

- Full feature work station
- Tank-mounted dryer

The range that meets all your requirements

Because everyone needs compressed air, ALUP has designed a full range of piston compressor from 2 to 10 HP, for all types of applications. From DIY to industrial users, the PRACTIC HLE, HLE and HLE-S ranges meet your compressed air needs.

PRACTIC HLE

- Reliable easy workmates
- Direct or belt driven
- Oil lubricated models

HLE

- High end reliable comprehensive power
- Direct or belt driven
- Single or dual stage for all demands

HLE-S

- Silent versions for installation close to workstation
- Silenced versions with integrated dryer for high demands

Piston technology

The Piston Compressor

A piston compressor consists of one or more cylinders with pistons driven by a motor. The air is sucked into the cylinder and then compressed, in one or more stages to the operational pressure. After compression, the compressed air passes through the after-cooler and continues on to the air tank.

Application areas

Piston compressors are mostly suitable for small compressed air requirements; one-stage compressors for pressures up to about 8 bar, while several stage versions can produce up to 15 bar. Operation should be intermittent. An air-cooled piston compressor's load level must not exceed 60-70%. After 2 minutes of compression, the compressor must rest for at least 1.5 minutes. We recommend keeping the total compression time per day to a maximum of approximately 4 hours.

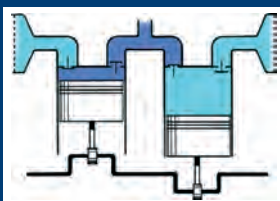

The one-stage compressor

A one-stage compressor has one or more cylinders, each of which compresses air from atmospheric pressure to operational pressure.

Multi-stage compressor

A multi-stage compressor has two or more cylinders connected in series in which air is gradually compressed to the final pressure. Between steps, the compressed air is cooled with air, thereby improving efficiency, while achieving a much higher pressure than a one-stage compressor.

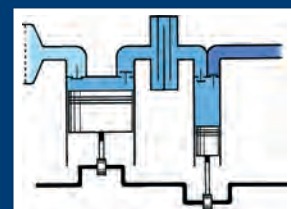

PRACTIC HLE range

The PRACTIC HLE range is perfectly adapted for individual and small users who very occasionally need compressed air for their own usage. The range offers a 2 HP head available with direct or belt driven technology, mounted on a small tank (wide range of capacities possible) which ensures you obtain a reliable compressor adapted to small compressed air needs.

Key benefits

- User-friendly
- Low noise level
- Small power single phase motor
- Lightweight and mobile
- Large choice of small tanks

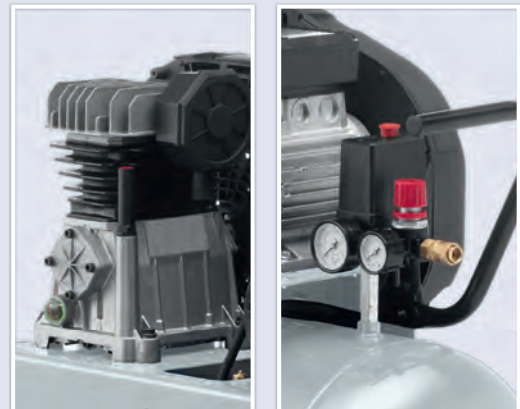

Direct drive

Great technology and simple operation suitable for a large range of applications:

Features

- User-friendly
- Low noise level
- Small power single phase motor
- Lightweight and mobile
- Large choice of small tanks

Applications

- Blowing
- Nailing & stapling
- Air/water spraying
- Inflating
- Hobby painting



Belt drive

Great belt driven technology developed for simple but reliable operation.

Features

- Wheel set included
- Slow speed pump engineered technology

Applications

- Screwing
- Impact wrenching
- Washing
- Hammering
- Professional blowing
- Rotorbital sanding
- Painting



HLE range - direct drive

The direct driven HLE range offers both 8 and 10 bar compressors which are ideal for small workshops. These piston compressors have been designed to correspond exactly to the needs of a small workshop where activities demanding a low compressed air flow are common. This range includes special configurations for those looking for more protection, comfort and compactness.

Key benefits

- User-friendly
- Low power single phase motors
- Pre-wired, ready to plug in
- Mobile or portable for easy handling (wheel set kit included)
- Large choice of tanks
- Low maintenance
- Pressure regulator for precise pressure control
- Quick fit connector



Features

- Cable and accessories storage
- Lightweight for easy transport
- Top tray with non-slip surface
- Large inflatable tires suitable for outdoor use
- Pressure regulator and filter on air outlet
- Extra high flow air outlet for heavy tools
- Sucker or rubber feet for perfect stability
- Roll bar, vertical handle

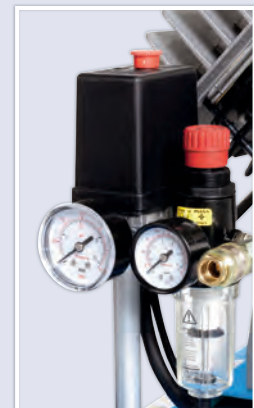
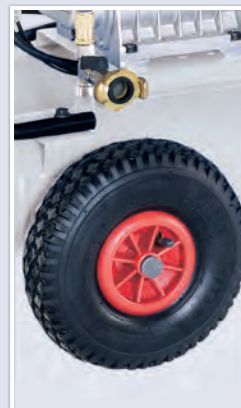

Applications

- Blowing
- Nailing & stapling
- Painting
- Washing
- Light hammering
- Impact wrenching



HLE range - belt drive (10 bar)

This range offers user-friendliness and lower operating temperatures, reliable power and performance. The single stage piston pump is designed with large cylinder bore and stroke, so that it can be run at low speed. Low noise levels and high comfort are the most important benefits. Moreover, it reduces working temperatures and wear, while also increasing reliability.

Key benefits

- Durability and reliability
- Better cooling
- User-friendly
- Low maintenance
- Low noise level of the pump
- User comfort



Features

- Double air outlets with quick connectors
- Robust metal belt guard
- Cast iron cylinder
- Easy oil check and refilling
- Slow speed pump engineered technology
- Mobile up to 200 Liters
- Large ventilation fan
- Mono and three phases motors



Applications

- Professional washing
- Orbital sanding
- Professional blowing
- Professional screwing
- Professional gravity painting
- Impact and ratchet wrenching



HLE range - belt drive (11 & 15 bar)

All the compressors in this offer are two stage, ensuring higher performance, air flows and pressures. The 11 bar compressors are ideal for higher power production purposes while the 15 bar offer is suitable for high pressure applications such as truck tire inflation. This range comes with approved high pressure components such as the vessel to guarantee safe and efficient use.

Key benefits

- Cast iron cylinder for durability and reliability
- Low maintenance
- Large capacity tanks
- Robust steel belt guard
- Silencing inlet filter (7.5 and 10 HP)
- Separated start delta cubicle with on/off and main switch



Features

- Cast iron cylinder for durability and reliability
- 3-phase motors
- Large ventilation fan for better cooling
- Suitable for high pressure applications (such as HGV or tractor tires)
- Robust steel belt guard



Pump



Air filter



Cubicle

Applications

- Orbital sanding
- Professional blowing
- Professional screwing
- Professional gravity painting
- Professional washing

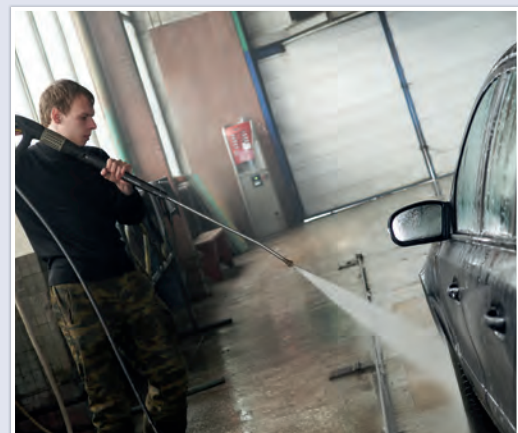

HLE-S range – low noise

The HLE-S range focuses on a reduced sound level. With its engineered design maintenance is simplified and footprint has been reduced. The range is easy to use thanks to the control panel including the following functionalities: pressure gauge, hour meter, on/off button, emergency button and maintenance.

Key benefits

- A low noise level
- Canopy design has been studied to improve ventilation while minimizing noise levels.
- The motor compressor frame is mounted on anti-vibration pads to ensure a longer lifetime of the unit.
- Due to its low noise level the HLE-S can be installed close to the place of compressed air use.
- User-friendly operation
- Easy access



Features

- Tank included in the canopy
- Double air outlet with quick fit connector
- Hose to drain oil from compressor
- Simple access to all electrical components
- Large electrical fan for efficient cooling (on 7.5 and 10 HP)
- The front panel is mounted on hinges allowing easy access to the main service components (oil refill, air filter, belt) which simplifies maintenance and control

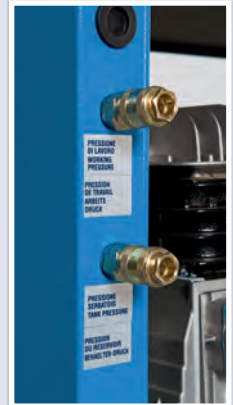
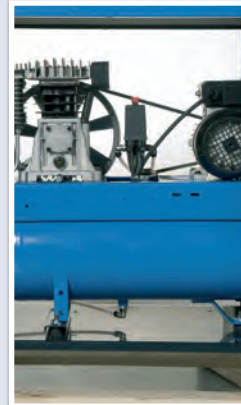

Applications

- Orbital sanding
- Professional blowing
- Professional screwing
- Professional gravity painting



HLE-S range - low noise and dry air

The HLE-S range offers a complete air supply system ensuring high air quality. As these tank-mounted compressors are fitted with a standard DW fridge dryer as well as an electronic drain, your compressed air network is better protected against rust, corrosion and pollution. The HLE-S range guarantees the usage of clean and dry compressed air where 95% of the condensate is eliminated.

Key benefits

- Dry air immediately upon start
- Protection of the downstream equipment, process and manufactured products
- Simplified and low cost installation due to smaller footprint
- Elimination of leakage risk thanks to clean and dry compressed air
- Energy savings due minimal pressure drop



Features

- Reduced footprint
- Piping specifically designed for a minimal pressure drop
- On/off button for possible anticipated start of the dryer
- Dew point indicator to control air quality and dryer efficiency



Applications

- Professional orbital sanding
- Professional blowing
- Professional screwing
- Professional gravity painting



Technical specifications

PRACTIC HLE range

Description	Vessel	Pressure	Power			Air displacement		Noise level	Volt	Start	Dimensions		Pump	
	liter	bar	hp	kW	RPM	l/min	CFM	LwA dB(A)			WxLxH mm	Weight kg		
HLE 0208-W-24	24	8	2	1.5	2850	222	7.8	94	230/1/50	DOL	280x585x580	24	FC 2	Direct drive
HLE 0208-W-50	50	8	2	1.5	2850	222	7.8	94	230/1/50	DOL	390x780x660	34	FC 2	
HLE 0209-W-27	27	10	2	1.5	1075	255	9.0	93	230/1/50	DOL	355x820x655	41	NS12	Belt drive
HLE 0209-W-50	50	10	2	1.5	1075	255	9.0	93	230/1/50	DOL	395x840x730	44	NS12	
HLE 0209-W-90	90	10	2	1.5	1075	255	9.0	93	230/1/50	DOL	490x970x850	56	NS12	

HLE range - direct drive

Description	Vessel	Pressure	Power			Air displacement		Noise level	Volt	Start	Dimensions		Pump
	liter	bar	hp	kW	RPM	l/min	CFM	LwA dB(A)			WxLxH mm	Weight kg	
HLE 0208-W-6	6	8	2	1.5	2850	240	8.5	96	230/1/50	DOL	460x440x450	19	F 241
HLE 0208-W-10	10	8	2	1.5	2850	240	8.5	96	230/1/50	DOL	355x380x640	19	F 241
HLE 0208-W-24	24	8	2	1.5	2850	240	8.5	96	230/1/50	DOL	280x585x580	22	F 241
HLE 0208-W-50	50	8	2	1.5	2850	240	8.5	96	230/1/50	DOL	390x780x660	32	F 241
HLE 0208-W-90	90	8	2	1.5	2850	240	8.5	96	230/1/50	DOL	455x970x800	43	F 241
HLE 0310-W-24	24	10	3	2.2	1450	340	12.0	93	230/1/50	DOL	555x625x785	44	GV34
HLE 0310-W-2x11	2x11	10	3	2.2	1450	340	12.0	93	230/1/50	DOL	625x810x615	56	GV34

HLE range - belt drive (10 bar)

Description	Vessel	Pressure	Power			Air displacement		Noise level	Volt	Start	Dimensions		Pump
	liter	bar	hp	kW	RPM	l/min	CFM	LwA dB(A)			WxLxH mm	Weight kg	
HLE 0211-W-90	90	10	2	1.5	1075	255	9.0	93	230/1/50	DOL	485x970x835	63	NS12S
HLE 0211-D-90	90	10	2	1.5	1075	255	9.0	93	400/3/50	DOL	485x970x835	63	NS12S
HLE 0311-W-90	90	10	3	2.2	1050	393	13.9	93	230/1/50	DOL	485x970x890	66	NS19S
HLE 0311-D-90	90	10	3	2.2	1050	393	13.9	93	400/3/50	DOL	485x970x890	66	NS19S
HLE 0311-W-200	200	10	3	2.2	1050	393	13.9	93	230/1/50	DOL	560x1400x990	100	NS19S
HLE 0311-D-200	200	10	3	2.2	1050	393	13.9	93	400/3/50	DOL	560x1400x990	100	NS19S

Technical specifications

HLE range - belt drive (11-15 bar)

Description	Vessel	Pressure	Power			Air displacement		Noise level	Volt	Start	Dimensions		Pump
	liter	bar	hp	kW	RPM	l/min	CFM	LwA dB(A)			WxLxH mm	Weight kg	
HLE 0411-D-200	200	11	4	3	1400	514	18.2	96	400/3/50	DOL	560x1400x1010	112	NS29S
HLE 0411-D-270	270	11	4	3	1400	514	18.2	96	400/3/50	DOL	500x1490x995	117	NS29S
HLE 0511-D-270/HLE 0511-DY-270	270	11	5.5	4	1000	653	23.1	95	400/3/50	DOL - Y/D	500x1490x995	124	NS39
HLE 0511-D-500/HLE 0511-DY-500	500	11	5.5	4	1000	653	23.1	95	400/3/50	DOL - Y/D	600x1940x1315	190	NS39
HLE 0711-D-500/HLE 0711-DY-500	500	11	7.5	5.5	750	950	33.5	102	400/3/50	DOL - Y/D	600x1940x1315	215	NS59S
HLE 1011-D-500/HLE 1011-DY-500	500	11	10	7.5	900	1130	39.9	102	400/3/50	DOL - Y/D	600x1940x1315	220	NS59S
HLE 0611-D-500/HLE 0611-DY-500	500	11	7.5	5.5	1250	827	29.2	102	400/3/50	DOL - Y/D	600x1940x1315	215	NS39
HLE 0415-D-300	300	15	4	3	1000	367	13.0	96	400/3/50	DOL	500x1640x995	170	NS29S
HLE 0515-D-300/HLE 0515-DY-300	300	15	5.5	4	800	522.4	18.4	95	400/3/50	DOL - Y/D	500x1640x1195	185	NS39
HLE 0515-D-300V	270 V	15	5.5	4	800	522.4	18.4	95	400/3/50	DOL	600x835x1950	180	NS39
HLE 0715-D-500/HLE 0715-DY-500	500	15	7.5	5.5	600	760	26.8	102	400/3/50	DOL - Y/D	600x1940x1315	245	NS59S
HLE 1015-D-500/HLE 1015-DY-500	500	15	10	7.5	750	942	33.3	102	400/3/50	DOL - Y/D	600x1940x1315	250	NS59S
HLE 0615-D-500/HLE 0615-DY-500	500	15	7.5	5.5	1000	626	22.1	102	400/3/50	DOL - Y/D	600x1940x1315	225	NS39

HLE-S range

Description	Vessel	Pressure	Power			Air displacement		Noise level	Volt	Start	Dimensions		Pump	Dryer T Version
	liter	bar	hp	kW	RPM	l/min	CFM	LpA (4m) dB(A)			WxLxH mm	Weight kg		
HLE 0209-WS-27	27	10	2	1.5	1075	255	9.0	61	230/1/50	DOL	430x760x845	80	NS12S	
HLE 0209-DS-27	27	10	2	1.5	1075	255	9.0	61	400/3/50	DOL	430x760x845	80	NS12S	
HLE 0309-WS-27	27	10	3	2.2	1350	320	11.3	62	230/1/50	DOL	430x760x845	81	NS12S	
HLE 0309-DS-27	27	10	3	2.2	1350	320	11.3	62	400/3/50	DOL	430x760x845	81	NS12S	
HLE 0411-DS	-	11	4	3	1450	514	18.2	68	400/3/50	DOL	635x820x795	143	B4900	
HLE 0511-DS / HLE 0511-DYS	-	11	5.5	4	1370	653	23.1	68	400/3/50	DOL - Y/D	635x820x795	150	B5900B	
HLE 0712-DS/HLE 0712-DYS	-	12	7.5	5.5	1400	827	29.2	68	400/3/50	DOL - Y/D	760x1230x875	229	B6000	
HLE 1012-DS/HLE 1012-DYS	-	12	10	7.5	1300	1210	42.7	68	400/3/50	DOL - Y/D	760x1230x875	248	B7000	
HLE 0411-DS-270	270	11	4	3	1450	514	18.2	68	400/3/50	DOL	635x1470x1360	213	B4900	
HLE 0511-DS-270/HLE 0511-DYS-270	270	11	5.5	4	1370	653	23.1	68	400/3/50	DOL - Y/D	635x1470x1360	224	B5900B	
HLE 0511-DS-500/HLE 0511-DYS-500	500	11	5.5	4	1370	653	23.1	68	400/3/50	DOL - Y/D	635x1900x1480	267	B5900B	
HLE 0711-DS-500/HLE 0711-DYS-500	500	11	7.5	5.5	1400	827	29.2	68	400/3/50	DOL - Y/D	760x1900x1520	369	B6000	
HLE 1011-DS-500/HLE 1011-DYS-500	500	11	10	7.5	1300	1210	42.7	68	400/3/50	DOL - Y/D	760x1900x1520	388	B7000	
HLE 0511-DS-500-plus/HLE 0511-DYS-500-plus	500	11	5.5	4	1370	653	23.1	68	400/3/50	DOL - Y/D	635x1900x1480	297	B5900B	Dryer
HLE 0711-DS-500 plus/HLE 0711-DYS-500-plus	500	11	7.5	5.5	1400	827	29.2	68	400/3/50	DOL - Y/D	760x1900x1520	399	B6000	Dryer
HLE 1011-DS-500 plus/HLE 1011-DYS-500-plus	500	11	10	7.5	1300	1210	42.7	68	400/3/50	DOL - Y/D	760x1900x1520	418	B7000	Dryer

* Star delta models: + 10 kg.

DRIVEN BY TECHNOLOGY DESIGNED BY EXPERIENCE



**CONTACT YOUR LOCAL
ALUP KOMPRESSOREN
REPRESENTATIVE**

Your authorized distributor

6999640220